

# Sigma Coffee Roasters



## PRODUCT CATALOGUE



# Sigma Coffee Roasters

## ABOUT SIGMA COFFEE ROASTERS

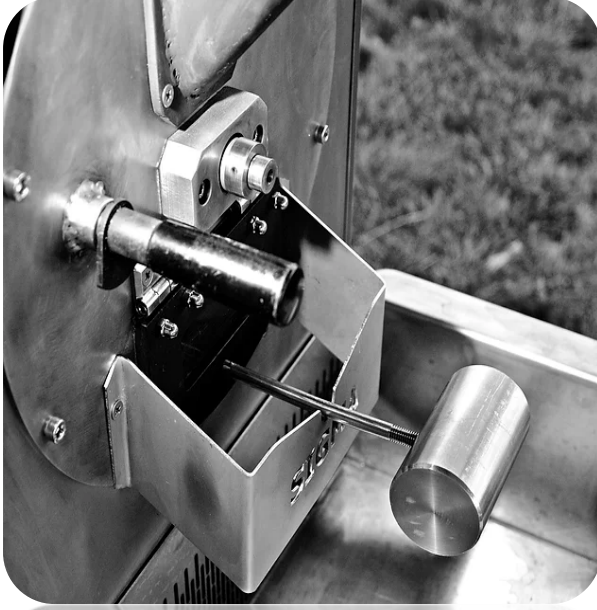

From day one, our commitment as Sigma Coffee Roasters have been simple - produce the highest quality products, at the best possible value and with truly superior client service. Sigma Coffee Roasters will be a great affordable alternative in the industry by bringing innovation to the field, adopting cutting-edge technologies and expanding to new customer sectors.

### Core Values at Sigma Roasters:

- ✓ Honesty and Fair Dealing,
- ✓ Customer Satisfaction,
- ✓ \*Demonstrating Respect to Individuals,
- ✓ Innovation,
- ✓ Team Work,
- ✓ Leadership,
- ✓ Productivity,
- ✓ Confidentiality,
- ✓ \* "Open Door" Policy.

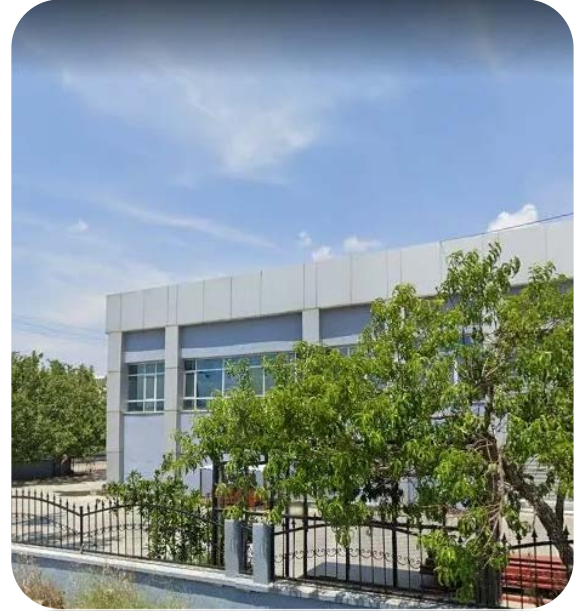

# Sigma Coffee Roasters



## **Our Mission:**

As Sigma Roasters, we are providing the goods and services that best suit the needs of sector, market and customer diversity being one of the competitive companies in the markets we are in, to ensure that the Sigma Roasters Family, employees, customers, suppliers, partners and consumers are happy and proud of it.

\*\*\*

## **Our Vision:**

Protecting the environment, our main goal is to become one of the leading company that provides solutions with reliable and innovative machines& equipment that will increase the quality of our customers' progress.

**"We are an experienced and dedicated team in this field for more than 15 years period."**

# Sigma Coffee Roasters

## SHOP ROASTERS

SIGMA SCR-2E ELECTRIC HOTAIR COFFEE ROASTER



### PRODUCT FEATURES

<b>Model Name</b>	<b>SCR-2E</b>
<b>Roasting Capacity</b>	<b>50 grams up to 2 kg per batch</b>
	<b>Roasting up to 6 kg per hour</b>
<b>Adjustable Hot Air Valve</b>	
<b>Adjustable digital thermostat</b>	
<b>Adjustable Temperature setting for roasting preferences</b>	
<b>Sampling Spoon &amp; Sight view glass for roasting control</b>	
<b>chaff collector</b>	
<b>Separate control panel</b>	



SIGMA MAKINE SANAYİ VE TİCARET LIMITED ŞTİ.  
Oğlanası Atatürk mah. 4. Cd. No:48, 35471 /İzmir, Türkiye  
www.sigmaroaster.com info@sigmaroaster.com  
Tel: +90 554 335 82 92

# Sigma Coffee Roasters



Roasting capacity (kg/h)	Light roast 6 kg - Medium roast 6 kg- Dark roast 4 kg of coffee beans.
Roasting time (minutes)	Light roast 18 min per batch - Dark roast 22-25 min. per batch
Batch capacity (kg)	In between 100 grams up to 2,000 grams of green coffee beans
Dimensions in cm (W*L-H)	71*80*82
Weight (kg)	75 kg
Voltage	110 - 220 - 230 - 380 - 415V
Frequency	50 - 60 Hz
Heat source	Digitally controlled - 3 kW
Heating system	Electric heated Hotair transfer
Number of motors	1
Motor Type:	German / Italian Made motors
Power consumption (kW/h)	3400 W
Power requirement (A)	1PH 16A - 3PH 8A
Color	Standard Red or Any RAL colors can be painted
Exhaust outlet Ø (mm)	100



SIGMA MAKINE SANAYİ VE TİCARET LIMITED ŞTİ.  
Oğlanası Atatürk mah. 4. Cd. No:48, 35471 /İzmir, Türkiye  
www.sigmaroaster.com info@sigmaroaster.com  
Tel: +90 554 335 82 92

# Sigma Coffee Roasters

## SHOP ROASTERS

### SIGMA SCR-2 GAS COFFEE ROASTER



### PRODUCT FEATURES

<b>Model Name</b>	<b>SCR-2G</b>
<b>Roasting Capacity</b>	<b>300 grams up to 2 kg per batch</b>
	<b>Roasting up to 8 kg per hour</b>
<b>Adjustable Hot Air Valve</b>	
<b>Adjustable digital thermostat</b>	
<b>Adjustable Temperature setting for roasting preferences</b>	
<b>Sampling Spoon &amp; Sight view glass for roasting control</b>	
<b>chaff collector</b>	
<b>Separate control panel</b>	

# Sigma Coffee Roasters



Roasting capacity (kg/h)	Light roast 10 kg - Medium roast 8 kg- Dark roast 6 kg of coffee beans.
Roasting time (minutes)	Light roast 12 min per batch - Dark roast 20 min. per batch
Batch capacity (kg)	In between 200 grams up to 2,000 grams of green coffee beans
Dimensions in cm (W*L-H)	108*70*99 cm
Weight (kg)	78 kg (171,6 lbs)
Voltage	110 - 220 - 230 - 380 - 415V
Frequency	50 - 60 Hz
Heat source	Digitally controlled – 8.000-10.000 Kcal
Heating system	Termal Transfer
Number of motors	3
Power consumption (kW/h)	550W
Power requirement (A)	1PH 11A - 3PH 6A
Color	Standard Red or Any RAL colors can be painted
Exhaust outlet $\varnothing$ (mm)	80



SIGMA MAKINE SANAYİ VE TİCARET LIMITED ŞTİ.  
Oğlanası Atatürk mah. 4. Cd. No:48, 35471 /İzmir, Türkiye  
www.sigmaroaster.com info@sigmaroaster.com  
Tel: +90 554 335 82 92

# Sigma Coffee Roasters

## SHOP ROASTERS

### SIGMA SCR-6 GAS COFFEE ROASTER



#### PRODUCT FEATURES

Model Name	SCR-6
Roasting Capacity	500 grams up to 6 kg per batch
	Roasting up to 18 kg per hour
Adjustable Hot Air Valve	
Adjustable digital thermostat	
Adjustable Temperature setting for roasting preferences	
Sampling Spoon & Sight view glass for roasting control	
chaff collector	
Separate control panel	



# Sigma Coffee Roasters



Roasting capacity (kg/h)	Light roast 30 kg - Medium roast 24 kg- Dark roast 18 kg of coffee beans.
Roasting time (minutes)	Light roast 12 min per batch - Dark roast 20 min. per batch
Batch capacity (kg)	In between 500 grams up to 6,000 grams of green coffee beans
Dimensions in cm (W*L-H)	160*152*162 cm
Weight (kg)	162 kg (356,4 lbs)
Voltage	110 - 220 - 230 - 380 - 415V
Frequency	50 - 60 Hz
Heat source	Digitally controlled – 18.000-25.000 Kcal
Heating system	Termal Transfer
Number of motors	4
Power consumption (kW/h)	2400W
Power requirement (A)	1PH 11A - 3PH 6A
Color	Standard Red or Any RAL colors can be painted
Exhaust outlet $\varnothing$ (mm)	150



SIGMA MAKINE SANAYİ VE TİCARET LIMITED ŞTİ.  
Oğlanası Atatürk mah. 4. Cd. No:48, 35471 /İzmir, Türkiye  
www.sigmaroaster.com info@sigmaroaster.com  
Tel: +90 554 335 82 92

# Sigma Coffee Roasters

## SHOP ROASTERS

### SIGMA SCR-15 GAS COFFEE ROASTER



<b>PRODUCT FEATURES</b>	
<b>Model Name</b>	<b>SCR-15</b>
<b>Roasting Capacity</b>	<b>1000 grams up to 15 kg per batch</b>
	<b>Roasting up to 45 kg per hour</b>
<b>Adjustable Hot Air Valve</b>	
<b>Adjustable digital thermostat</b>	
<b>Adjustable Temperature setting for roasting preferences</b>	
<b>Sampling Spoon &amp; Sight view glass for roasting control</b>	
<b>chaff collector</b>	
<b>Separate control panel</b>	

# Sigma Coffee Roasters



Roasting capacity (kg/h)	Light roast 75 kg - Medium roast 60 kg- Dark roast 45 kg of coffee beans.
Roasting time (minutes)	Light roast 12 min per batch - Dark roast 20 min. per batch
Batch capacity (kg)	In between 1000 grams up to 15,000 grams of green coffee beans
Dimensions in cm (W*L-H)	198*205*192 cm
Weight (kg)	354 kg (780 lbs)
Voltage	110 - 220 - 230 - 380 - 415V
Frequency	50 - 60 Hz
Heat source	Digitally controlled – 38.000-45.000 Kcal
Heating system	Termal Transfer
Number of motors	4
Power consumption (kW/h)	3000W
Power requirement (A)	1PH 14A - 3PH 8A
Color	Standard Red or Any RAL colors can be painted
Exhaust outlet Ø (mm)	200



SIGMA MAKINE SANAYİ VE TİCARET LIMITED ŞTİ.  
Ođlananası Atatürk mah. 4. Cd. No:48, 35471 /İzmir, Türkiye  
www.sigmaroaster.com info@sigmaroaster.com  
Tel: +90 554 335 82 92

# Sigma Coffee Roasters

## INDUSTRIAL ROASTERS

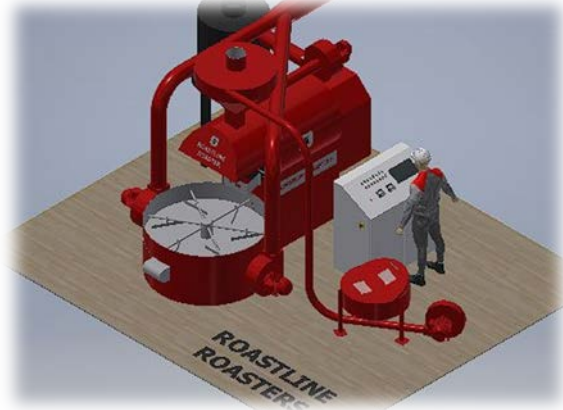

SIGMA MAKINE SANAYİ VE TİCARET LIMITED ŞTİ.  
Oğlanası Atatürk mah. 4. Cd. No:48, 35471 /İzmir, Türkiye  
www.sigmaroaster.com info@sigmaroaster.com  
Tel: +90 554 335 82 92

# Sigma Coffee Roasters

## INDUSTRIAL ROASTERS

### SIGMA SCR-30 COFFEE ROASTER



### PRODUCT FEATURES

#### Sigma Gas Coffee Roaster

Model Name	SCR-30
Roasting Capacity	10kg up to 30 kg per batch
	Roasting up to 150 kg per hour
Adjustable Hot Air Valve	
Adjustable digital thermostat	
Adjustable Temperature setting for roasting preferences	
Sampling Spoon & Sight view glass for roasting control	
chaff collector	
Separate control panel	

# Sigma Coffee Roasters

## TECNICAL SPECIFICATIONS

Roasting capacity (kg/h)	Light roast 150 kg - Medium roast 120 kg- Dark roast 90 kg of coffee beans.
Roasting time (minutes)	Light roast 12 min per batch - Dark roast 20 min. per batch
Batch capacity (kg)	In between 10 kg up to 30 kg of green coffee beans
Dimensions in cm (W*L-H)	230*285*298cm
Weight (kg)	1050 kg (2310 lbs)
Voltage	240 / 415 Volt, 3 Phase
Frequency	50 - 60 Hz
Heat source	Digitally controlled – 50.000-220.000 Kcal
Heating system	Termal Transfer
Number of motors	4
Power consumption (kW/h)	8,4Kw Max
Power requirement (A)	18A
Color	Standard Red or Any RAL colors can be painted
Exhaust outlet $\varnothing$ (mm)	300
Gas outlet	1"

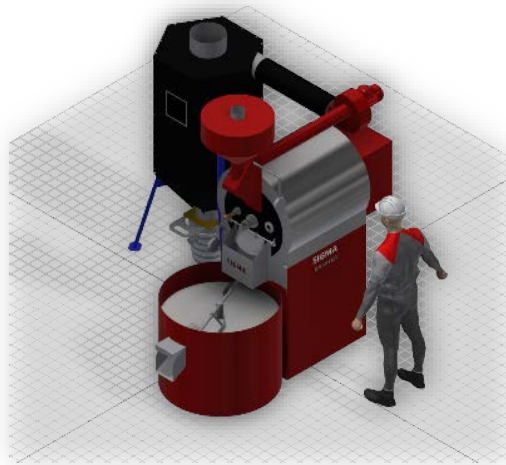
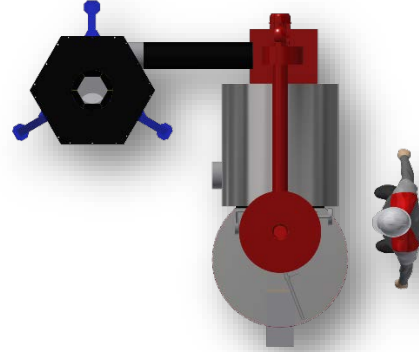
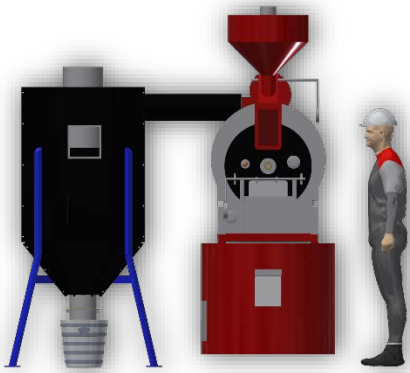

# Sigma Coffee Roasters

## INDUSTRIAL ROASTERS SIGMA SCR-60 COFFEE ROASTER



### PRODUCT FEATURES

#### Sigma Gas Coffee Roaster

Model Name	SCR-60
Roasting Capacity	20kg up to 60 kg per batch
	Roasting up to 300 kg per hour
Adjustable Hot Air Valve	
Adjustable digital thermostat	
Adjustable Temperature setting for roasting preferences	
Sampling Spoon & Sight view glass for roasting control	
chaff collector	
Separate control panel	

# Sigma Coffee Roasters

## TECNICAL SPECIFICATIONS

Roasting capacity (kg/h)	Light roast 300 kg - Medium roast 240 kg- Dark roast 180 kg of coffee beans.
Roasting time (minutes)	Light roast 12 min per batch - Dark roast 20 min. per batch
Batch capacity (kg)	In between 20 kg up to 60 kg of green coffee beans
Dimensions in cm (W*L-H)	310*310*360 cm
Weight (kg)	2210 kg (4860 lbs)
Voltage	240 / 415 Volt, 3 Phase
Frequency	50 - 60 Hz
Heat source	Digitally controlled – 70.000-260.000 Kcal
Heating system	Termal Transfer
Number of motors	5
Power consumption (kW/h)	10,6Kw Max
Power requirement (A)	24A
Color	Standard Red or Any RAL colors can be painted
Exhaust outlet Ø (mm)	300
Gas outlet	1"



SIGMA MAKINE SANAYİ VE TİCARET LIMITED ŞTİ.  
Oğlanası Atatürk mah. 4. Cd. No:48, 35471 /İzmir, Türkiye  
www.sigmaroaster.com info@sigmaroaster.com  
Tel: +90 554 335 82 92



# Sigma Coffee Roasters

## INDUSTRIAL ROASTERS

### SIGMA SCR-120 COFFEE ROASTER

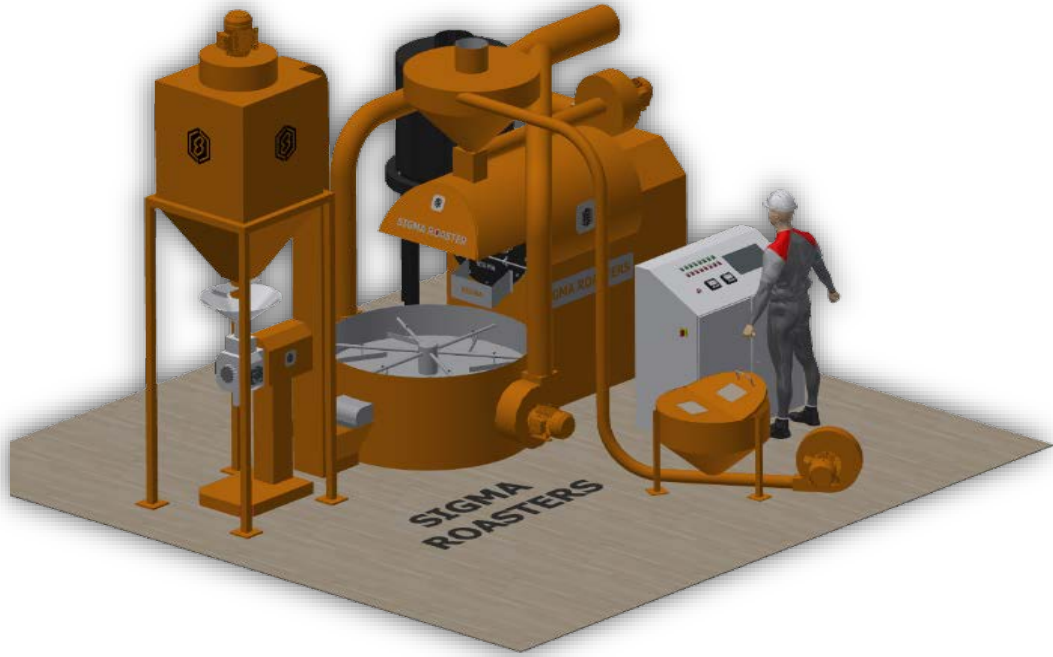

### PRODUCT FEATURES

#### Sigma Gas Coffee Roaster

Model Name	SCR-120
Roasting Capacity	40kg up to 120 kg per batch
	Roasting up to 600 kg per hour
Adjustable Hot Air Valve	
Adjustable digital thermostat	
Adjustable Temperature setting for roasting preferences	
Sampling Spoon & Sight view glass for roasting control	
chaff collector	
Separate control panel	

# Sigma Coffee Roasters

## TECNICAL SPECIFICATIONS

Roasting capacity (kg/h)	Light roast 600 kg - Medium roast 480 kg- Dark roast 360 kg of coffee beans.
Roasting time (minutes)	Light roast 12 min per batch - Dark roast 20 min. per batch
Batch capacity (kg)	In between 20 kg up to 60 kg of green coffee beans
Dimensions in cm (W*L-H)	340*340*370 cm
Weight (kg)	2620 kg (5760 lbs)
Voltage	240 / 415 Volt, 3 Phase
Frequency	50 - 60 Hz
Heat source	Digitally controlled – 110.000-360.000 Kcal
Heating system	Termal Transfer
Number of motors	5
Power consumption (kW/h)	11,4Kw Max
Power requirement (A)	25A
Color	Standard Red or Any RAL colors can be painted
Exhaust outlet Ø (mm)	300
Gas outlet	1"

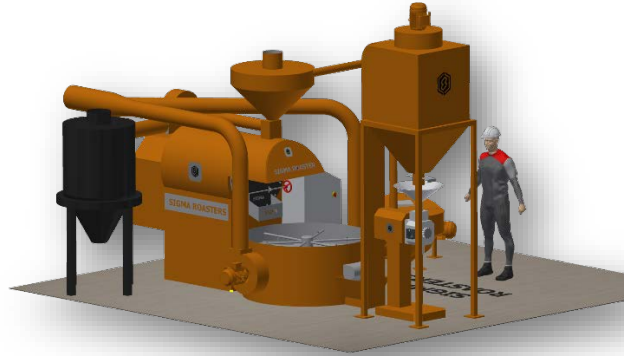
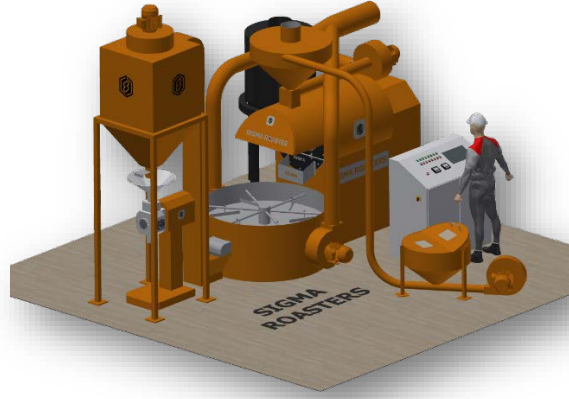

SIGMA MAKINE SANAYİ VE TİCARET LIMITED ŞTİ.  
Oğlanası Atatürk mah. 4. Cd. No:48, 35471 /İzmir, Türkiye  
www.sigmaroaster.com info@sigmaroaster.com  
Tel: +90 554 335 82 92

# Sigma Coffee Roasters

## INDUSTRIAL ROASTERS

### SIGMA SCR-240 COFFEE ROASTER



#### PRODUCT FEATURES

##### Sigma Gas Coffee Roaster

Model Name	SCR-240
Roasting Capacity	60kg up to 240 kg per batch
	Roasting up to 1200 kg per hour
Adjustable Hot Air Valve	
Adjustable digital thermostat	
Adjustable Temperature setting for roasting preferences	
Sampling Spoon & Sight view glass for roasting control	
chaff collector	
Separate control panel	

# Sigma Coffee Roasters

## TECNICAL SPECIFICATIONS

Roasting capacity (kg/h)	Light roast 1200 kg - Medium roast 960 kg- Dark roast 720 kg of coffee beans.
Roasting time (minutes)	Light roast 12 min per batch - Dark roast 20 min. per batch
Batch capacity (kg)	In between 20 kg up to 60 kg of green coffee beans
Dimensions in cm (W*L-H)	580*350*398 cm
Weight (kg)	3600 kg (7920 lbs)
Voltage	240 / 415 Volt, 3 Phase
Frequency	50 - 60 Hz
Heat source	Digitally controlled – 150.000-620.000 Kcal
Heating system	Termal Transfer
Number of motors	7
Power consumption (kW/h)	18 Kw Max
Power requirement (A)	30 A
Color	Standard Red or Any RAL colors can be painted
Exhaust outlet Ø (mm)	400
Gas outlet	1"

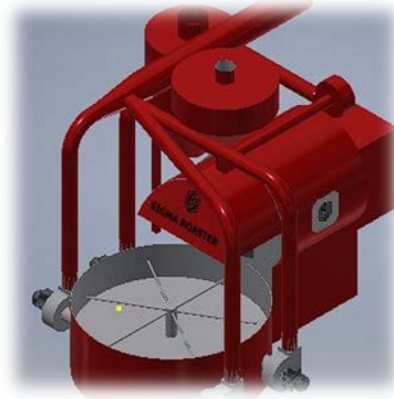

# Sigma Coffee Roasters

## COFFEE GRINDERS

### SCG-10 MINI COFFEE GRINDER



**Capacity:**  
**15kg superfine**  
**30 kg filter type.**  
**Electric=110-220 Single**  
**Phase or 380V, 3 Phase.**  
**Power=1,5hp**  
**Weight=32kg**  
**Dimensions=600x320x580**



SIGMA MAKINE SANAYİ VE TİCARET LIMITED ŞTİ.  
Oğlanası Atatürk mah. 4. Cd. No:48, 35471 /İzmir, Türkiye  
www.sigmaroaster.com info@sigmaroaster.com  
Tel: +90 554 335 82 92

# Sigma Coffee Roasters

## COFFEE GRINDERS

### INDUSTRIAL COFFEE GRINDERS



- Easy to adjustable grind thickness
- Long Life special hardened Discs
- User friend and easy to maintenance

### SCG-15

### SCG-20

### SCG-30



- |   |  |   |
|---|--|---|
| <ul style="list-style-type: none"><li>• 15cm hardened long life steel disc</li><li>• 30kg - 70 kg coffee per hour.</li><li>• Electric: 380V, 3Phase</li><li>• Power: 3HP</li><li>• Weight: 72 kg</li><li>• Dim.=35x640x98cm</li></ul> | <ul style="list-style-type: none"><li>• 20cm hardened long life steel disc</li><li>• 70kg - 150 kg coffee per hour.</li><li>• Electric: 380V, 3Phase</li><li>• Power: 5,5HP</li><li>• Weight: 120 kg</li><li>• Dim.=120x64x116cm</li></ul> | <ul style="list-style-type: none"><li>• 30cm hardened long life steel disc</li><li>• 110kg - 450 kg coffee per hour.</li><li>• Electric: 380V, 3Phase</li><li>• Power: 15HP</li><li>• Weight: 160 kg</li><li>• Dim.=150x110x170</li></ul> |
|---|--|---|

# Sigma Coffee Roasters

## ROASTING EQUIPMENT



Industrial Mixers



Destoner



Z Elevators



Screw Loaders

**WE OFFER HIGH QUALITY AND DURABLE ROASTING EQUIPMENT.**

**WE CAN PROVIDE COFFEE ROASTING EQUIPMENT SUCH AS ;**

- ◆ LOADERS,
- ◆ AFTERBURNERS
- ◆ DESTONERS
- ◆ MIXERS,
- ◆ STORAGE SILOS,
- ◆ FEEDING AND PLC CONTROLLING UNITS.

SIGMA MAKINE SANAYİ VE TİCARET LIMITED ŞTİ.  
Oğlanası Atatürk mah. 4. Cd. No:48, 35471 /İzmir, Türkiye  
www.sigmaroaster.com info@sigmaroaster.com  
Tel: +90 554 335 82 92

# Sigma Coffee Roasters

## SILO SYSTEMS SHOP TYPES

" Bean Silos are generally used to store roasted beans for demonstration purpose. There are different type of silos for storing roasted beans."



## INDUSTRIAL TYPES

" **Industrial** Silos are used to store big volume roasted beans for demonstration purpose. There are different type of silos for storing roasted beans 500kg – 10.000kg."

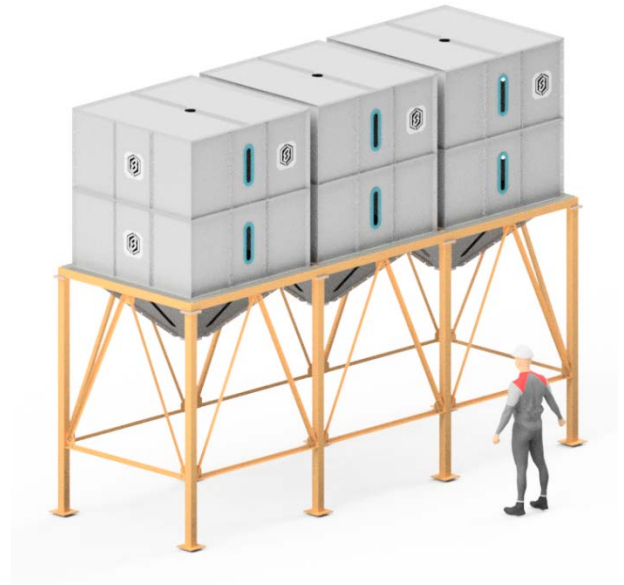



# Sigma Coffee Roasters

## SERVICES

### INDUSTRIAL ROASTING PLANTS & PROJECTS

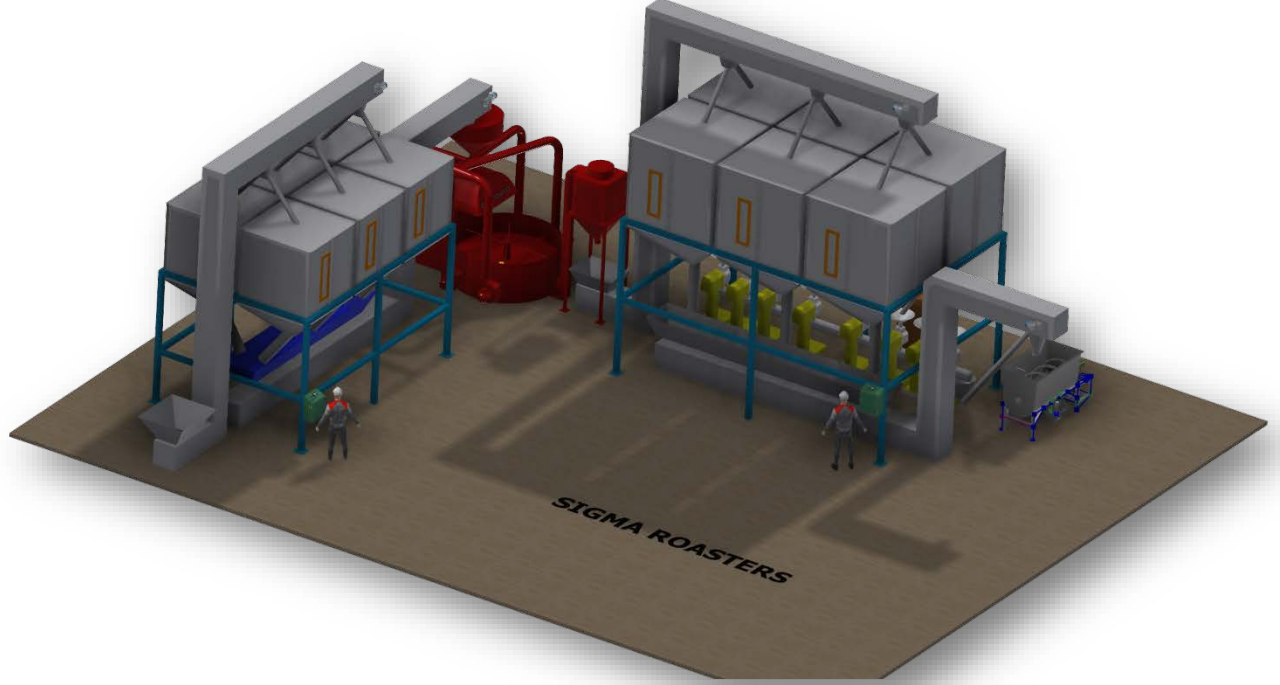

We can provide you different size of industrial coffee roasting projects with related equipment such as loaders, mixers, silos up to end of a processing line for feeding coffee grinders or packaging units.

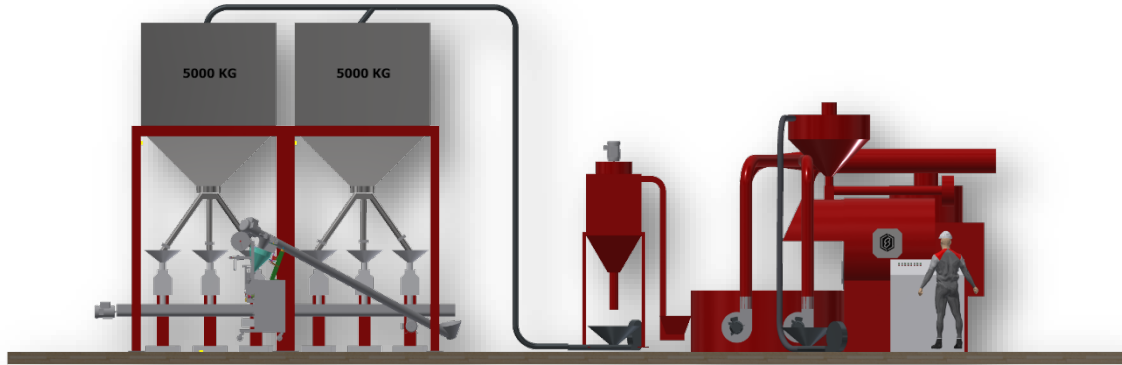

SIGMA MAKINE SANAYİ VE TİCARET LIMITED ŞTİ.  
Oğlananası Atatürk mah. 4. Cd. No:48, 35471 /İzmir, Türkiye  
www.sigmaroaster.com info@sigmaroaster.com  
Tel: +90 554 335 82 92

# Sigma Coffee Roasters

## SERVICES

ENGINEERING AND SPECIAL DESIGN PROJECTS



**We can adopt your projects from sketch to actual finish for your industrial engineering and machinery needs.**

SIGMA MAKINE SANAYİ VE TİCARET LIMITED ŞTİ.  
Ođlananası Atatürk mah. 4. Cd. No:48, 35471 /İzmir, Türkiye  
[www.sigmaroaster.com](http://www.sigmaroaster.com) [info@sigmaroaster.com](mailto:info@sigmaroaster.com)  
Tel: +90 554 335 82 92

# Sigma Coffee Roasters

## SERVICES

COFFEE ROASTING & COFFEE SUPPLY



We can provide you good quality green beans and roasted coffee beans for your current needs in different single origins.



SIGMA MAKINE SANAYİ VE TİCARET LIMITED ŞTİ.  
Oğlanası Atatürk mah. 4. Cd. No:48, 35471 /İzmir, Türkiye  
www.sigmaroaster.com info@sigmaroaster.com  
Tel: +90 554 335 82 92

# Sigma Coffee Roasters

We achieve our goals with  
customer satisfaction:

FROM GREEN BEANS.....



TO CUPS...

Sigma

- Ordering,
- Production,

Coffee

- Controlling,
- Commissioning,

Roasters

- Training at customer site,
- Fullfilment.